

User Manual

RGB2w laser light



Introduction

Thank you for purchasing our product.

To ensure proper operation, please read this manual carefully before using the product.

After reading it, keep it in a safe place for future reference.

General Information

* The following chapters explain important information about lasers in general, basic laser safety and some tips about how to use this device correctly. Please spend some time reading these information as some of them are critical for safe and efficient operation of this laser display system.



Caution

! This laser entertainment system is rated as a Class IV laser product and manufactured in accordance to EN 60825-1:2007. Avoid eye or skin exposure to direct or scattered radiation. Wear protective goggles of suitable optical density if necessary.

! If the laser is operated in a situation where health or property injury may occur the operation must be stopped immediately.

! The manufacturer and its distributors cannot be held responsible for any damages caused by improper use or misuse of this laser system. The owner/user is fully responsible for using this product in accordance to laser safety regulations of the country or state where the system is being used.

Please note that some other optical devices such as cameras, camcorders, video projector etc. can be damaged if exposed to excessive laser radiation.

Handling precautions

This laser system is a precision device that contains some sensitive opto-electronics components. DO NOT drop it or subject it to physical shock.

This laser system is not waterproof or dust-proof. Make sure to use an appropriate cover or enclosure if it is used in the rain, snow or similar severe environment conditions.

Do not leave the laser system in excessive heat such as in a car whilst in direct sunlight. High temperatures could cause some serious damage to the system.

The laser system contains precision electronic circuitry. Never attempt to disassemble the laser yourself.

If the laser is suddenly brought in from the cold into a warm room, condensation may form on the laser and internal parts. If condensation forms on the laser body, do not use the laser as this may damage the laser system. If there is condensation, wait until it has evaporated before using it.

What is a laser and how does it work?

What is a LASER?

The laser is a bunch of energy waves (streams of photons called radiation) with the same amplitude and phase that are flowing in the same direction; meaning they are coherent – they stick together and form a laser beam.

The width of a single wave is measured in nano-meters and defines the colour and visibility of the laser beam. The visible spectrum of the human eye is roughly between 400nm and 700nm, going from violet to a dark red colour. A human eye is most sensitive to a green light of around 555nm, meaning that a 1W of green laser will always appear more visible than 1W of any other colour laser. 1W of quality laser light is very powerful and although it doesn't sound like much it can burn eye retinas, skin and clothes or even start a fire!

What makes the laser visible?

Mainly it is the particles of dust in the air that the laser beam hits on its path. That's why we "laserists" use haze or smoke machines to make lasers more visible. Too much of the haze or smoke will kill it, but the right amount will make all the difference between no show and a great show. When outdoors, lasers mainly reflect off dust and mist in the air but due to unpredictable wind conditions we can never make sure the hazers or smoke machines will be effective enough. And that's why we use high power lasers for outdoor shows – to substitute for the lack of dust, haze and smoke.

How far does it go?

Depending on the power output of the system and weather conditions, the laser can be visible for miles – that is why we need to be cautious about aircrafts when performing outdoor shows. And if you get a system that is powerful enough then yes, it can reach the Moon.

Colours

Standard full colour analogue lasers use three primary colours: Red, Green and Blue. By mixing those together you can pretty much get any secondary colour:

Red + Blue = Magenta

Red + Green = Yellow

Green + Blue = Cyan

Red + Green + Blue = White

Of course the number and precision of the colours is determined by the modulation, stability and linearity of the system. If the system is not stable enough, it will produce different colours every time it is used, making it virtually impossible to match the colours of two systems at any one time. This is very often the case with systems from far east manufacturers and with re-branded lasers that are being presented as European makes.

Scanning System

A scanning system is essentially two tiny mirrors, each moving on X or Y axis. By working together they can "scan" the laser beam in all directions. Once a shape is scanned more than 20 times per second, it appears static to the human eye. So any shape drawn by a laser is actually produced by one single laser beam running around like crazy. Every scanning system has a mechanical limit of how fast it can move its mirrors and therefore how many points it can display at any one second and that is usually represented in Points Per Second at a certain scanning angle, i.e. 8 degrees.

Laser Safety First!

! Before proceeding any further, please read the following safety page very carefully. It could help you avoid dangerous and hazardous situations which could lead to serious injury or property damage.

! Any laser system classified as a Class 4 laser must be used with caution. If you are not an experienced laser operator we would strongly recommend that you attend a laser display safety course as soon as possible, and ideally before this laser system is used in public areas. There are various places in Europe where you can attend quality training and even a one day course will give you a good amount of valuable information to safely start with.

Unless you are very competent with the use of lasers and about the laser safety, make sure you follow these basic laser safety rules:

- 1: Never look directly into a laser beam.
- 2: Never look directly into laser aperture if the laser system is switched on.
- 3: Be aware that lasers can burn the eye retina, skin or cause fires if not used correctly.
- 4: Never perform Audience Scanning – that's when laser beams and effects hit an audience directly. Always project with the laser above audience head level – at least 3m above floor level.
- 5: When performing outdoors, avoid pointing the laser at aircrafts, buses, trains, etc.
- 6: Never leave the laser system unattended when it's switched on.
- 7: Always check for reflective surfaces within the laser range – these can be very dangerous (i.e. mirror behind the bar in a club could bounce the beam into bar attendant's eye).
- 8: Never hesitate to use the Emergency STOP if you think there's a fault within the laser system or a potential danger to a person/object caused by the laser performance.

Installation of the System

! The manufacturer is not liable for damages or an injury caused by improper installation of the system.

The installation should be carried by a qualified installer who should follow the Laser Safety Regulations of respective country.

where non-authorized person could get an access to.

3: Always make sure the system is properly tightened down and that it cannot get loose and move as a result of sound vibrations, cable pull or similar.

4: Always use a safety rope.

5: Ensure that all the cables have enough leverage just in case they get caught.

6: Ensure that the system is placed at least 20cm away from walls or any other objects including drapes etc.

7: Ensure that the system is placed well away from any heat sources including spotlights, moving heads, radiators, etc. Make sure there is a sufficient air-flow around the laser system.

8: It is essential that the fan openings are never covered during the laser operation.

9: Always follow the Laser Safety Regulations of respective country where the laser is being used.

Control System

The overall performance of any of our laser systems is also dependent on the control system that you use for operating the laser as well as the correct device configuration in the laser control software. There are many laser control options on the market but we mainly recommend control systems from these two manufacturers:

Pangolin Laser Systems

Showtacle

Scanning System

The product warranty does not cover the damages to the scanning system caused by improper use of the scanning system or by incorrect programming. Therefore it is essential to understand how the scanning works and where are the limits of it. In this manual we will explain only the basics of it but it is the responsibility of every user to educate themselves so they can avoid damage being caused to the scanning system and costly repairs.

A laser beam comes from a laser module and hits the two moving mirrors of the scanning system. These mirrors are mounted on the scanner shafts and are moved by the scanner rotors, one on X and one on Y axis.

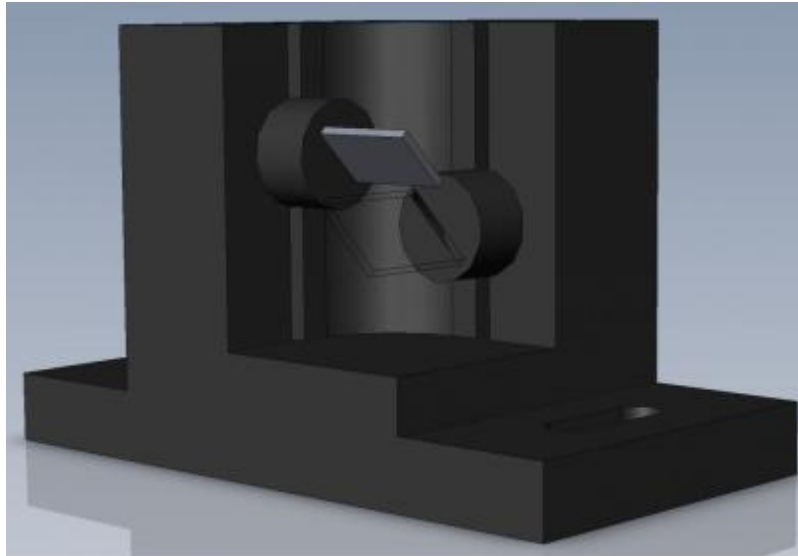

An effect such as tunnel (circle) is displayed by a repetitive mechanical movement of the scanners. For each scanning system and effect, there's a maximal scan rate that is defined by mechanical load, scanner mirror size and weight, complexity of displayed picture and size of the projection (an angle under the laser beam is being projected). A different scanning systems have different scan-rate limits. It is essential to operate the scanning system at scan-rates within its maximal limit at all times to prevent it from overload damage.

How to establish correct Scan-rate and maximal number of points in an effect

Each effect (picture) contains a different number of graphical points which defines the actual shape of the effect. The more points an effect contains, the lower the maximum scan rate will be in relation to the scanning angle.

As an example we'll work with the star effect shown below and with the parameters of quality scanning system:

Let's say the star effect is made of 300 graphical points (including non-visible blanking points) and we know that the maximal scan-rate of our scanning system is 35kpps @ 8 degrees (= 35.000 points per second at 8 degrees projection angle). We also know that we display the star 35 times per second which is a default frame rate of the control software we are using.

So we need to display 300 points 35 times per second = 10.500 pps. This means that we could display 3 of these stars beside each other within one single laser effect and that it would be quite close to the scanner limit ($3 \times 10.500 = 31.500$ pps). This however applies than 8 degrees on both axes! If we start to increase the size of the projection (scanning angle) it is necessary to either lower the number of points within the effect or drop down the scan-rate in the control software (FPS) to a safe level - which may result in flicker.

From the example above we can also determine how many points this scanning system is able to project if the scanning angle is not more than 8 degrees:

$35.000 \text{ points} / 35 \text{ Frames Per Second} = 1.000 \text{ pps}$. This is the absolute maximum of how many points we should be using when programming an effect if the scanning angle is not more than 8 degrees.

In the following pictures you see the same star effect scanned at different scan rates at full scanning angle (60 degrees).

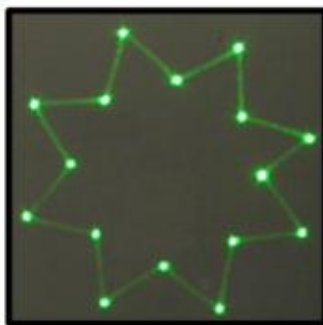

picture 1

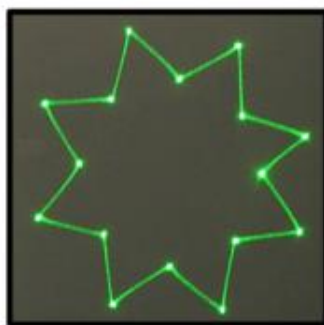

picture 2



picture 3

Picture 1: the scan rate and/or number of points is too low. The corner points are more visible than the lines between them and the whole effect flickers. The scan-rate and/or number of points needs to be increased.

Picture 2: the scan-rate and/or number of points is about right. The whole effect has more or less the same intensity and does not flicker.

Picture 3: further increasing of the scan-rate and/or number of points results in the effect starting to distort, firstly around corners only. This indicates that you are exceeding the maximal scan rate of the scanning system! If you operate the scanning system at scan-rates higher than the maximum scan-rate of the scanning system the scanners will get damaged irreversibly due to overheated coils damaging rotor magnets.

Connection Diagram

Please check that all the signal and power leads are correctly installed and that the safety keys are inserted in all necessary positions.

Basic connection diagram

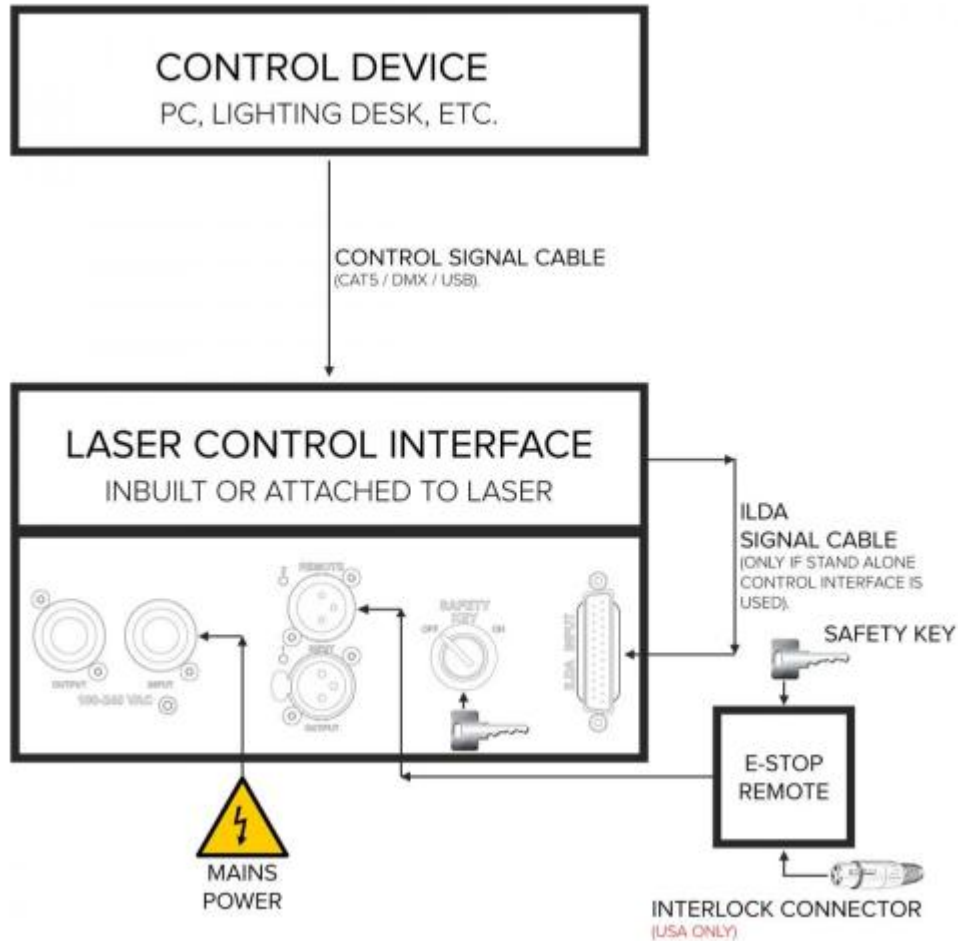

* Both E-STOP Remote safety key and laser system safety key must be inserted and switched to ON position in order to disable the interlock.

! USA ONLY : Interlock Connector must be inserted in the E-order to disable the interlock.

Power Connections Method

Please connect power as following :

L (live wire) =brown wire

E(earth wire)=yellow/green double color wire N

(null line) =blue wire

When connecting,ensure that the voltage and frequency of power supply match the power requirement of the product.

This product is Class 1 protection equipment.The yellow-green double colors wire must be earthed by qualified personnel. Before installation,ensure that the voltage and frequency of power supply match the power requirements of product.In power supply and voltage fluctuation large areas,we suggest you to use 110V or 220V or use voltage regulator to supply power.After electrical connection,this product will have a few seconds self-check action, self-check finished can be used.

Important:It is essential that Yellow/green double color wire is correctly earthed and that electrical installation conforms to all relevant standards

DMX Connection method

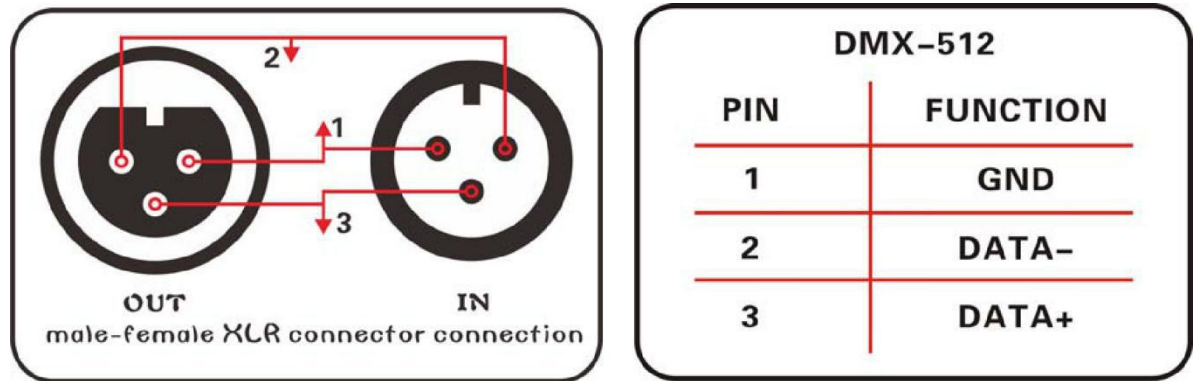

DMX control signal connection must be made with a two core-screened cable,with each core having at least a 0.5mm diameter.Please use the product's signal cable OUT and IN as connection.The signal OUT and IN cables connection shown as above picture.

Note:Please do not connect the signal cable OUT and IN in other way except above shown.

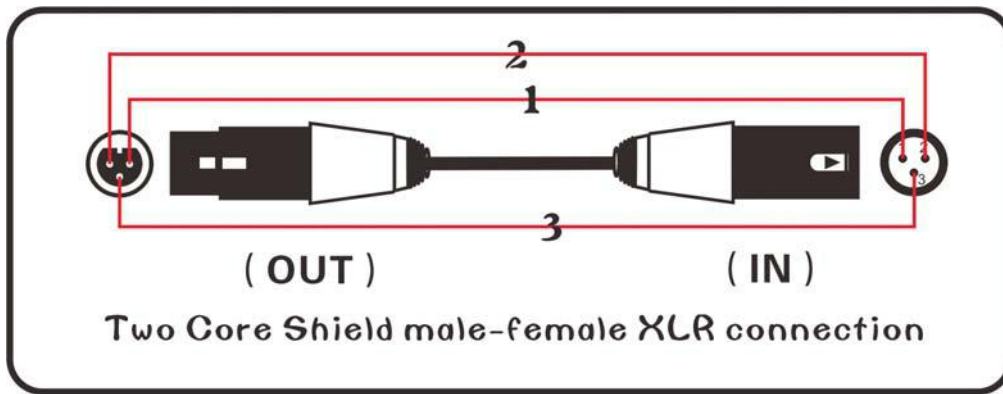

This product accepts digital control signals in protocol DMX512(1990).The amount of lighting fixtures connected in parallel is no more than 32.Connect the DMX controller's **Output** to the first lighting fixture's **Input** cable with a 2 core XLR signal cable(Shown as above),connect the first lighting fixture's **Output** cable to the second lighting fixture's **Input cable** and connect the rest light fixtures in the same way.Eventually,connect the last lighting fixture's Output cable to a DMX terminator

Under DMX-512 signal control mode,the last lighting fixture's DMX Output must be connected with a DMX terminator.This prevents electrical noise from disturbing and corrupting the DMX control signals.The DMX terminator is simply an XLR connector with a 120Ω(ohm) resistor connected across pins 2 and 3,which is then plugged into the output socket on the last projector in the chain.Then connections are illustrated above.

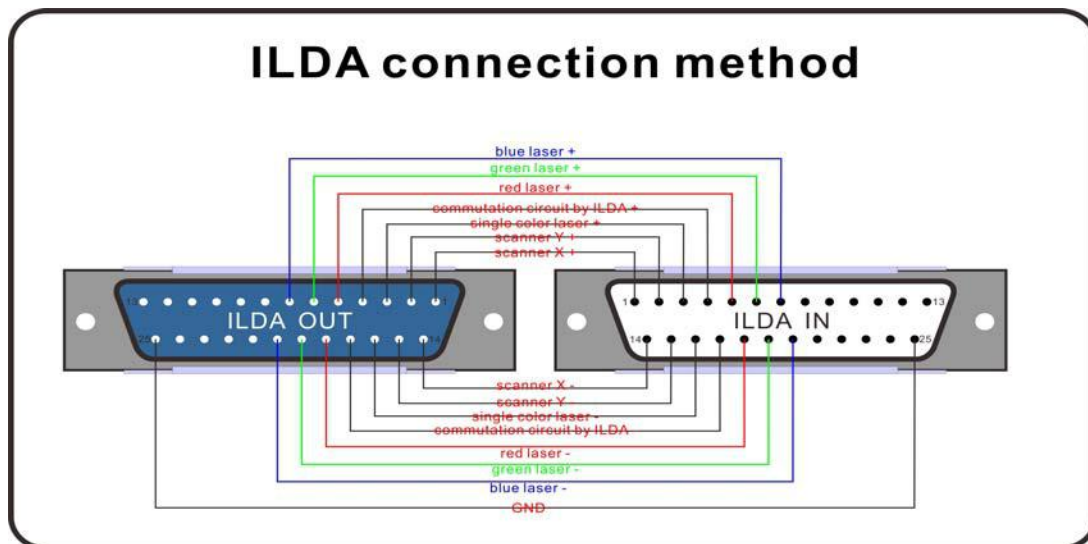

ILDA control signal connection method:

Connection built through product male/female DB 25 degree socket.Like above picture. In addition to the above connections, ILDA signal cannot be connected in any other way.

LCD Menu and function introduction



Choose function by press “ UP” and” Down” buttons

Press “ ENTER” to cofirm the function

Press “ RETURN” back to last menu.

●LCD setting of menu:

First grade menu	Second grade menu	3 rd grade menu
1. DMX-512 DMX-512 mode	1. Address 001 Choose light DIP	
2. Iplay	1. Show Choose effect	Show 001
	2. Music Sound	1. OFF 2. ON
3. SDplay	1. Play	1. 001 ild 2. FileName
	2. List	1. 001 eff 2. ListName
	3. Mode	1.PlayOne 2.PlayAll
	4. Music	1. OFF 2. ON
4. Testing	1. Scan	1. Scan 2. 30KPPS
	2. Color	1.Single1-7 2.RGY 3.RBP 4.GBA 5.RGB 6.WYAP
5. Setting	1. Light	1. ON 2. ON 5S

	2. OneBeam	1. OFF 2. ON
	3. Master	1. OFF 2. ON
	4. Channel	1. 13CH 2. 5CH
	5. TTLMode	1. OFF 2. ON
6. Default	1. Yes 2. No	

●DMX-512 Channel function

1. DMX chnnel function

Channel		Value	Content
CH1	Laser off	0~29	Laser off
	IPLAY	30~59	1. Auto manual control
		60~89	2. Auto
		90~119	3. Sound manual control
		120~149	4. Sound
	SDPLAY	150~179	5. Auto manual control
		180~209	6. Auto play
		210~239	7. Sound manual control
240~255		8. Sound control	

2. IPLAY mode 13CH :

Channel		Value	Content of control
CH1	Laser off	0~29	Laser off
	IPLAY	30~59	Auto manual control
		60~89	Auto
		90~119	Sound manual control
120~149		Sound manual control	
CH2	Patterns	0~255	Every 3 value choose one pattern
CH3	Patterns rotation	1~127	Rotary angle choose
		128~159	30 degree rotary speed choose
		160~191	180 degree rotary speed choose
		192~223	Rotary speed in opposite direction
		224~255	Rotary speed in positive direction
CH4	Patterns flip horizontal	1~127	Flip horizontal position selection
		128~159	Flip horizontal speed selection
		160~191	
		192~223	
		224~255	

CH5	Pattern flip vertical	1~127	Flip vertical position selection
		128~159	Flip vertical speed selection
		160~191	
		192~223	
		224~255	
CH6	Patterns horizontal moving	1~127	Horizontal moving position selection
		128~159	Horizontal moving speed selection
		160~191	
		192~223	
		224~255	
CH7	Pattern vertical moving	1~127	Vertical moving position selection
		128~159	Vertical moving speed selection
		160~191	
		192~223	
		224~255	
CH8	Pattern size	1~127	Pattern size selection
		128~159	Zoom out speed selection
		160~191	Zoom in speed selection
		192~223	Zoom in speed selection
		224~255	
CH9	Pattern zoom in/out	1~255	Pattern size selection
CH10	Patterns gradually drawing	1~127	Gradually drawing speed selection
		128~255	
CH11	Hot spot effects	1~127	Pattern scanning speed selection
		128~255	
CH12	Color	0~63	Fixed color
		64~95	Color selection
		96~127	
		128~159	Color change rotation speed selection
		160~191	
		192~223	
		224~255	Gradually drawing speed selection
CH13	Full RGB	1~255	255 color

3. IPLAY mode 25CH :

Channel		Value	Content
CH1	Laser off	0~29	Laser off
	IPLAY mode	30~59	Auto manual control
		60~89	Auto play
		90~119	Sound manual control
		120~149	Sound control
CH2	Pattern A choice	0~255	Every 3 value choose one pattern
CH3	Pattern A slection	1~127	Rotation angle selection
		128~159	30 degree rotation speed selection
		160~191	180 rotation speed slection
		192~223	Rotary speed in opposite direction
		224~255	Rotary speed in positive direction
CH4	Patterns A horitional rotation	1~127	Horizon rotation angle selection
		128~159	Horitional pattern rotation selection
		160~191	
		192~223	
		224~255	
CH5	Pattern A Vertical rotation	1~127	Vertical rotaion angle selection
		128~159	Vertical rotation speed slection
		160~191	
		192~223	
		224~255	
CH6	Patterns A horization moving	1~127	Horization rotation position selection
		128~159	Horizontal moving speed selection
		160~191	
		192~223	
		224~255	
CH7	Patterns A vertical moving	1~127	Vertical moving position selection
		128~159	Vertical moving speed selection
		160~191	
		192~223	
		224~255	
CH8	Pattern A zoom in/out	1~127	Pattern size slection
		128~159	Zoom in speed selection
		160~191	Zoom out speed selection
		192~223	Zoom speed slection
		224~255	
CH9	Pattern A zoon size	1~255	Pattern zoom in/out size selection
CH10		1~127	gradually drawing selection

	Patterns gradually drawing	128~255	
CH11	Pattern A hot pot	1~127	Scanning speed selection
		128~255	
CH12	Patter A color mode	0~63	Fixed color slection
		64~95	Chaning color speed selection
		96~127	
		128~159	Effect speed selection
		160~191	
		192~223	
		224~255	Gradually drawing speed selection
CH13	Patter A full color	1~255	255 colors selection
CH14	Pattern B slection	0~255	Choose one patter every 2 value
CH15	Pattern B rotation	1~127	Rotation angle slection
		128~159	30 degree rotation angle selection
		160~191	180 rotary speed slection
		192~223	Rotary speed in opposite direction
		224~255	Rotary speed in positive direction
CH16	Patter B horizational rotation	1~127	Horizontal angle selection
		128~159	Horizontal speed selection
		160~191	
		192~223	
		224~255	
CH17	Pattern B vertical rotation	1~127	Vertical angle selection
		128~159	Vertical speed selection
		160~191	
		192~223	
		224~255	
CH18	Pattern B horizontal rotation	1~127	Horizontal moving direction slection
		128~159	Horizontal moving speed selection
		160~191	
		192~223	
		224~255	
CH19	Pattern B vertical	1~127	Vertical moving direction selection
		128~159	Vertical moving speed selection
		160~191	
		192~223	
		224~255	
CH20	Pattern B Zoom	1~127	Pattern size selection
		128~159	Zoom in speed selection

		160~191	Zoom out speed selection
		192~223	Zoom speed selection
		224~255	
CH21	PatternB size	1~255	Pattern size selection
CH22	Pattern B gradually drawing	1~127	gradually drawing speed selection
		128~255	
CH23	Pattern B pot	1~127	Scan speed selection
		128~255	
CH24	Pattern B color mode	0~63	Fixed color selection
		64~95	Changing color effect selection
		96~127	
		128~159	Water effect selection
		160~191	
		192~223	
		224~255	gradually drawing speed selection
CH25	Pattern B full color	1~255	255 color selection

4. SDPLAYmode list

Channel		Value	Content
CH1	Laser on/off	0~29	Laser off
	SDPLAY mode	150~179	Auto manual control
		180~209	Auto play control
		210~239	Sound manual control
		240~255	Sound control
CH2	Effect list	0~255	Every 28 value choose one effect library
CH3		0~255	Every 10 value choose one effect library
CH4	Patterns selection	0~255	Every 28 value choose one pattern library
CH5		0~255	Every 10 value choose one pattern library
CH6	Play control	0~127	Auto, sound all play
		128~255	Single cue loop, Auto, Sound control
	Patterns rotation	1~127	Rotation Z
		128~159	30° angle speed adjustment
		160~191	180 ° angle speed adjustment
		192~223	Invert rotation speed adjustment
	224~255	Rotation speed adjustment	
CH7	HR	1~127	Rotation X
		128~159	Rotation speed adjustment
		160~191	
		192~223	
		224~255	

CH8	VR	1~127	Rotation Y
		128~159	Rotation speed adjustment
		160~191	
		192~223	
		224~255	
CH9	HB	1~127	Position X
		128~159	Position speed adjustment
		160~191	
		192~223	
		224~255	
CH10	VB	1~127	Position Y
		128~159	Position speed adjustment
		160~191	
		192~223	
		224~255	
CH11	SI	1~127	Scale
		128~159	Scale down speed adjustment
		160~191	Scale up speed adjustment
		192~223	Scale up & down adjustment
		224~255	
CH12	DR	1~127	Visible point speed adjustment
		128~255	
CH13	BE	1~127	Scanner rate speed adjustment
		128~255	
CH14	CO	0~63	Static color
		64~95	Color shift speed adjustment
		96~127	
		128~159	Rainbow speed adjustment
		160~191	
		192~223	
		224~255	Write in speed adjustment

● **Preparing SD card files:**

Create a “PESLASER” folder, then create “ddrfiles”, “ildfiles”, “Playlist” folder in “PESLASER”. See Fig.1



Fig. 1

1.Put the ishow ddr format document in “ddrfiles” folder. (Caution: The name limited 8 character). For example fig.2.



Fig. 2

Note: You could create a new folder for saving DDR format document, but the folder name limited 8 character. For example fig. 3.



Fig. 3

2.Put the ild format document in “ildfiles” folder. (Caution: The name limited 8 character). For example fig.4

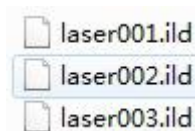

Fig. 4

Note: You could create a new folder for saving ild format document, but the folder name limited 8 character. For example fig. 5.

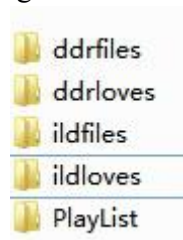

Fig. 5

3.Put the eff and pla format document in “PlayList” folder. Eff and pla format can edit by notepad. For example fig. 6.

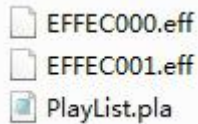

Fig. 6

● **Edit effect**

1. Put new ild or ddr format document in “ildfiles” or “ddrfiles” folder.
2. Copy a EFFEC000.eff-> Paste it-> rename it (for example: “loves001.eff”->edit it by notepad, see fig. 7.

```
1, (ddrfiles/HEPING12. ddr, TI=5, SI=180, CO=150, )
2, (ddrfiles/HEPING06. ddr, TI=10, SI=180, CO=80, )
3, (ddrfiles/HEPING12. ddr, TI=5, SI=150, CO=250, )

6, (ildfiles/Aurora9. ild, TI=5, )
7, (ildfiles/Aurora18. ild, TI=5, )
8, (ildfiles/Aurora19. ild, TI=5, )
```

Composed by four parts: effect number + file path + time + effect, see below:

Effect number	File path	Time	Effect
1,	ddrfiles/heping12.ddr,	TI=5,	SI=180, CO=150,
2,	ddrfiles/heping06.ddr,	TI=10,	SI=180, CO=80,
3,	ddrfiles/heping12.ddr,	TI=5,	SI=150, CO=250,
6,	ildfiles/Aurora9.ild,	TI=5,	
7,	ildfiles/Aurora18.ild,	TI=5,	
8,	ildfiles/Aurora19.ild,	TI=5,	

(1) Time in seconds, for example TI=5, play it 5s.

(2) That have night effect: RO(Rotation Z),HR(Rotation x),VR(Rotation Y),HB(Position X),VB(Position Y),SI(Scale),DR(Visible point),BE(Scanner rate),CO(Color).

Note: The character “,” and “()” must be use.

● **Add the effect to “PlayList.pla” list, see Fig. 8.**

```
1, (EFFEC000. eff)
2, (EFFEC001. eff)
3, (EFFEC002. eff)
4, (EFFEC003. eff)
4, (loves001. eff)
```

Fig. 8

Rear View



Product technical parameters

- 1.Voltage:AC90~240V 50~60HZ±10%
- 2.Power consumption:120W
- 3.Laser source: diode.
- 4.Laser power /wavelength:
1x500mW Red(638nm)
1x500mW Green (520nm)
1 x 1000mW Blue (445nm)
- 5.Beam size: 4mm at aperture
- 6.Divergence: <1.5mrad-full angle
- 6.Colors:RGB full color
- 7.External Modulation:Analog
- 8.Laser Patterns:256 pieces built-in laser patterns
- 9.DMX Channel:13/25CH
- 10.Scanner system: 25kpps
- 11.Control signal:DMX-512 international standard signal
- 12.Control mode:Music,auto,master-slave and DMX-512,ILDA Control
- 13.Cooling system:fan
- 14.Operation environment :Indoor
- 15.Operation temperature:-10°C~40°C
- 16.Net Weight :5.5kg
- 17.Dimension Size : 27(L)x 20(w) x 16(H) cm

Maintenance

To prolong the life of the product, it is very important to do maintenance work. The environment is harsh outdoors, or if the product is idle for a long time, damp, smoke or particularly dirty surroundings can cause greater accumulation of dirt on its cover and housing. So it should be cleaned to maintain an optimum light output and at the same time to prevent it from being corrupted by acid gas.

Cleaning frequency depends on the environment in which the fixture operates. Soft cloth and typical glass cleaning products should be used for cleaning. It is recommended to clean product at least once every 20 days.

Friendly notice: Do not use any organic solvent, e.g. alcohol to clean housing of the apparatus.

Troubleshooting

Problems	Action
The product doesn't switch on	Power connection is not correct. Re-connect the power.
	Power supply is damaged or abnormal. Call a qualified personnel to fix it.
	Connection of control board is not correct. Call a qualified personnel to fix it.
The product can turn on, but no light coming out.	Control mode is wrongly setting up. Resetting it according to instruction book
	Control section is damaged. Call a qualified personnel to fix it.
The beam appears dim	The product is too hot. Take ventilation measures to make it cool.

Note: This product is under warranty for 1 year (From the date of delivery), 1 years after can provide paid maintenance services. But if it is because of natural disasters or user's operation not according to manual. We won't provide warranty.